

THE "ELECTRONIC POEM" IN THE PHILIPS PAVILIONA Rich and Rare Experience of a World of Wonder

The silvery and lustrous Philips Pavilion looms before the visitor to the Brussels' International Exhibition like a giant shell of bizarre shape from some exotic sea-bed. Involuntarily, the visitor is struck and his attention captured by the gently curving surfaces of this highly remarkable building with its pointed peaks rising to height of some 70 feet. The building, as well as the "Electronic Poem" performed in it, is the creation of Le Corbusier, the celebrated French-Swiss architect. The Poem is the Pavilion's only exhibit and in its synthesis of art and the latest scientific and technical achievements, it is one show at the "Expo 1958" that is really unique. Every day thousands upon thousands of visitors stream into the Philips Pavilion which, not only for its daring design and extraordinary construction, but also for the strange and extravagant light-and-sound show given inside of it, has become one of the most discussed attractions of the Exhibition.

The visitor walks into an almost empty enclosure bounded by bare and lofty walls that curve over his head into saddle surfaces finally sweep up to three apices, thus forming narrowing chimneys, as it were. Surprized, he gazes about him, seeking a central point; but the underlying idea is difficult to grasp. Peering into the semi-obscurity above, in one of the apices he suddenly recognises the large-scale model of an atom, hanging by a scarcely visible thread. His glance wanders to a second apex, and there he discovers a nude figure. To start off with, the visitor is only half aware of what he sees, for the deathly quiet interior does not yield up its secret at first glance. At this stage he wonders whether the model and the figure are meant to symbolise Matter and Mind. Is it a question of human defencelessness facing the threat of danger? While the observer, his head full of all that he has seen in other pavilions, is still asking himself what is going to happen, the "Poem" starts; a wave of images, sounds, light and colour breaks over him.

It only lasts eight minutes, this cataract of optical and acoustic effects that, changing second by second and at even shorter intervals, fill up the space that a moment ago was quite lifeless, penetrating into its furthest corners. Gigantic pictures appear on the asymmetric curved walls that converse above one's head.

There are birds, fishes, reptiles, masks, skeletons, idols, girls looking anxiously upward, buildings and steel structures are askew, mushroom explosions and ruins, crippled children, but also film-stars, inventors, tools and many other symbols or abstract compositions symbolizing whole epochs. All this is intended to represent the dramatic story of mankind's development right up to the present day. It is necessarily a somewhat sketchy account, but the overall effect of this selection of pictures is to make it clear how, since its creation, humanity has struggled for harmony and happiness and defended itself against sorrow and catastrophe, how it has been torn back and forth between love and hate, between the elevated and unattainable ideal and the inevitable irritations of everyday life.

Le Corbusier's scenario comprises seven pictorial sequences, namely "The Formation of the Earth", "Matter and Mind", "Out of the Depths into the Dawn", "Man made unto himself Gods", "Men build their World", "Harmony" and "The Heritage of Posterity". The apotheosis of the "Electronic Poem" concerns the mission of humanity: the task of preserving what has been acquired and of handing it on to posterity is symbolized by the gesture of a hand that receives and bestows.

If there were nothing to see in the pavilion but these black and white images, they would not be anything out of the ordinary; they would be a sort of picture book, nothing more and nothing less. It is only the auxiliary elements provided by electro-acoustics and electronic control techniques that - strange as it may seem - really bring the kaleidoscope to life. One half would be pointless without the other, and the two things together would be nothing if the whole were not taking place inside that mystical architectural shape. It is only by virtue of the place where it is staged that the "Electronic Poem" is an instrument of allusion, interpretation and pronouncement that is as keen as a surgeon's scalpel, and as mordant as many an unpalatable truth.

On entering the Pavilion, the visitor notices certain dark patches on the walls; they obviously have a purpose, but what it is he is unable to guess. They prove to be loudspeakers, from which electronic music is now pouring forth. Heard for the first time by a willing and attentive listener, it all sounds extremely odd and yet, at the same time, this music takes you into a world of wonder; it is rather like a trip to another planet, which makes you frightened but curious. On the other hand, the indifferent visitor hears nothing but highly remarkable sound effects in this piece of electronic music, for which Le Corbusier left the French composer Edgar Varèse a free hand. It is made up of rattling and whistling sounds, it is threatening and plaintive by turns, it thunders and it roars.

At one point a human voice is imitated; it is somewhat like a coloratura and, like the other sounds, it moves about within the enclosed space, from left to right and back, upwards and down again. So palpably does it swing hither and thither that the audience try to follow its path. You can see their heads moving. At another point - when the picture of the atomic explosion appears - a thunderous roar fills the Pavilion. There are about 400 loudspeakers, and when the din from all of them at once starts to verge on the intolerable, the visitor really has a sense of being in the middle of things, and almost believes he can feel the air trembling. Like the images, the sounds are constantly changing, scarcely leaving the listener time to reflect. The human ear is exhausted by the great number of unusual impressions it has to respond to. The volume varies between 40 and 130 Phon. The aesthetic scale of these electronic sounds ranges from muted music of the spheres (illustrating the birth of human hope) to crashing dissonance (when a catastrophe enters into the plot of the drama).

To the pictorial and acoustic components are added light and colour. The picture-and-sound sequences are accompanied by luminous effects conjured up out of several hundred red, blue, green, violet and yellow fluorescent lamps. At other times immense patches of light of complementary or clashing colours are projected by ingenious systems of mirrors on to the walls around the big film pictures at the same time, coloured stripes move round the walls; these stripes are images of a rotating disc projected by an epidiascope. Once or twice there is darkness for a split second and, in the two hollows in the roof, the atom model and the naked figure become visible; irradiated with invisible ultra-violet light, they now shine forth and exercise their spell on all. But then comes a burst of light from the colour organ; the radiance dies away and swells again, or dissolves into flashes that hurt the eyes.

For this complicated interplay of space, image, sound, light and colour, intended to convey a message and not merely to astonish the visitor, it is necessary that scene should follow scene with almost unimaginable exactitude. The light and sound show adheres to a time-table of seconds and fractions of a second. Le Corbusier called this time-table "minutage", but it would be apter to call it "secondage". During intervals as brief as before-mentioned, such and such a picture must be screened, certain sounds must be heard, and the prescribed light and colour accompaniments must be in action. A moment later the scene has changed, but all the components of the spectacle still fit together as if made to measure. And so it all continues right up to the "final chord". Compressed in this manner, the message that Le Corbusier is trying to convey demands of the visitor much attention and concentration and even a certain mental attitude.

- 4 -

But the rapid changes of scene are necessary if any impression is to be made upon the audience, who are tired out from their wanderings around the Exhibition, and whose heads are still full of the Atomium, sputniks, Circarama and the thousand other technical wonders they have witnessed. The sensations registered on the faces of visitors are various. The scale of feelings ranges from profound shock to hilarity, from admiration to scepticism. However, they all agree on one point: the "Electronic Poem" is fascinating and astonishing, and must not be missed.

LE CORBUSIER'S "ELECTRONIC POEM" - THE PHILIPS PAVILION
(Brussels' World Exhibition 1958)

by

JANIS XENAKIS

-.-.-.-.-

Due to the initiative of Mr Louis Kalff, Director of the department for art with Philips, the management of the firm contacted Le Corbusier early in 1956 and asked him to design and execute their pavilion for the Brussels' World Exhibition.

"I should like you to design the Philips-Pavilion in such a way, that there is no need for showing even the tiniest manufactured article. That means to prove by most adventurous means, how much we are being guided by technical progress in the field of sound and light effects for the future".

Le Corbusier: "I shall not create a pavilion, but an Electronic Poem - a jar, which contents are a concoction of the following poetical ingredients:

- | | |
|-----------|-----------------|
| 1) light | 4) rhythm |
| 2) colour | 5) sound |
| 3) image | 6) architecture |

All these components will represent an organic synthesis accessible to the Public, demonstrating at the same time the accessories used by Philips in the course of production. The Electronic Poem will last 8 minutes".

Le Corbusier himself combined light, colour, and image. He elaborated the optical "textbook", the visual transformation of real facts of the presence, ranging from the micro-cosmos of atoms, and the machines in factories, to the smiling face of a baby and the chaos among the stars.

For composing the complementary music, being unseparable from both the real and the psychic phenomena, Le Corbusier choose one of the most prominent contemporary composers Edgar Varèse, the "young man of 70", the explosive forerunner of sound-disassociation, rhythmic distortion and disentagled melodies. (Duration of this music piece 8 minutes). I was allotted a smaller task by Le Corbusier, to compose an interlude.

- 2 -

Originally the contour of the pavilion was planned as a closed structure with concave, convex, and plane surfaces of wire netting and projecting "gun tubes" of cement, whilst the entire construction should be fastened by innumerable suspensions to a structure, serving at the same time as roof.

The pavilion holds about 500 persons. Furthermore it accommodates the projection, light and sound as well as the thyatron apparatus for the automatic release. Music and sound-effects are recorded on magnetic tape.

In October 1956 Le Corbusier asked me to study the architectural and technical design of the pavilion. I had to discard any preconceived idea and start from anew to find an architectural solution corresponding to this extraordinary combination of artistic activities. (The artistic components were defined by Mr Le Corbusier and Mr Kalff).

The result of the analysis fits the following equations:

- 1) Hall for the audience = 500 visitors - standing only
 - a) Interior surface between 400 and 500 m² ("stomach")
 - b) Two tube-like corridors for entrance and exit.
- 2) Characteristics of the auditorium and electro-acoustics system - Extremely short reverberation time; avoiding of parallel surfaces (numerous possibilities for reflections); no tetrahedrons (reverberation through bisection of "dièdres"); arched surfaces with continuously changing radius.
- 3) Projection of light = Receding surfaces, gathering vertical, diagonal, and oblique light; movable, catching, receding, and rotating rooms.
- 4) Technical construction = Plain, well planned, if possible tested surfaces; perhaps self-supporting bowls or shells for the ceiling.

Through personal contact with B. Lafaille and the knowledge of his studies, we were already accustomed to conoids and hyperbolic-paraboloids. They are the means through which the above-mentioned equations could be solved. It is logical that a structure consisting of a combination of conoids and hyperbolic-paraboloids forms not only a practical solution but at the same time a convincing architectural image.

The resulting form is both mathematically strict and plastically organic:

Fig. 1 - Interior

Fig. 2 - Peaks resulting from the first two hyperbolic-paraboloids

Fig. 3 - The third peak balancing and "lifting" the first two

Fig. 4 - Elaboration of architectural features.

The ceiling was intended to be either corrugated or self-supporting. How could such a construction be realized ?

The work took several weeks. Also many relations had to be established in order to find two personalities, suited for a difficult task: One, a physicist (Mr. Vreedenburgh, Professor of Mechanics at the University of Delft), and the other, a construction engineer (Mr. Duyster, administrator of the firm STRABED, Brussels).

Within a fortnight, they accomplished

- a) the theoretical calculation of the hyperbolic-paraboloid bowls for the ceiling;
- b) an equilibrium test by means of a scaled down model in the laboratory.

According to these investigations the construction of the entire pavilion in hyperbolic-paraboloids was possible without difficulties. The bowls of the selfsupporting ceiling are of 5 cm concrete. Thus the pavilion of the Brussels' World Exhibition 1958 represents a technical novelty with regard to the synthetic application of new (hyperbolic-paraboloid) surfaces.

Not often does a team of top technicians and physicists cooperate at such a short notice in any architectural work. But here the difficulty of overcoming a mutual ignorance was eliminated. It was the attitude of these men, their scientific as well as their technical integrity which resulted in a creation never performed before.

Here I must mention not only Mr. Vreedenburgh and Mr. Duyster but especially Mr. Kalff, a perspicacious, patient and insistent expert and Mr. Tak, the acoustics specialist of Philips.

Now the Electronic Poem can be freely displayed in its cocoon of revolving spaces.

In close connection with the instructions issued by Le Corbusier the technical instructions were thus defined:

Panoramic screens, continuously reproducing and resolving pictures; apparatus, alternately casting light and dark colours; flashing effects, ranging from the visible to the invisible area; cinema illuminations of vaults and curved skylines aflame or frozen to ice; magics and tragedies by optic means; plastic ideas of starting life All these countless means and effects keep the audience for 8 minutes of uninterrupted performance, wavering between uncertainty and instantaneous comprehension, transfers them into a world where they cannot anticipate the sequence of light and sound waves.

By 400 odd loudspeakers, distributed on the inner, absorbing surfaces of the pavilion (7500 m³) the sound is acoustically conducted from one polyphonic sound source to the other. 15 magnetic, automatic light and sound tracks direct the total programme in one ceaseless movement.

The Philips Pavilion and Le Corbusier's Electronic Poem are an outstanding example for the synthesis of optical, acoustical, architectural and technical interplay of human capacities.

- I. 1) "Stomach" (Inner walls = 500 m²)
 2) Entrance
 3) Exit
 4) Free curves
- II. 1) Ceiling of inner walls
 First two points
 2) Entrance
 3) Exit
 4) Hyperbola
 5) Joining arch
 6) Second point
 7) Hyperbolic paraboloid surface
 8) First point
 9) Conoid surface
 10) Free curve
- III. 1) Entrance
 2) First point
 3) Second point
 4) Third point
 5) Hyperbolic paraboloid surface
 6) Joining arch
 7) Conoid surface
 8) Free curve ("Stomach")
 9) The third point supports and holds the first two in equilibrium
- IV. 1) Refinement of the architectural lines
 2) First point
 3) Second point
 4) Third point
 5) The conoid lines are replaced by hyperbolic paraboloids
 6) Entrance
 7) Conoid
 8) Hyperbolic paraboloid
 9) Free Curve
 10) Hyperbolic curve

THE PHILIPS PAVILION AT THE BRUSSELS' WORLD EXHIBITION 1958Technical RealizationAutomatic control

Le Corbusier wrote the script of the "Electronic Poem", giving Varèse complete freedom as regards its composition, with the exception of two moments for which absence of sound was required. In order to arrive at a full automatic control of the performance, a script had to be made on the basis of the scenario. This script accurately determines every single configuration that has to be executed during each of the basic divisions of time in the performance.

This script, which might be termed the "Score of the basic time sections" forms the programme for the control apparatus. It indicates exactly every action this apparatus should govern, in order to call forth the required picture, colour, and sound effect of the moment. Such a programme must, therefore, contain all commands for every basic time section.

We speak of "commands", in the plural, because often several operations have to take place simultaneously e.g. with the light, with the colour, and with the sound. At such moments three commands are involved. The programme could be compared with a necklace composed of a number of parallel strings of beads, the beads representing the commands. This necklace is run along an extended finger, which traces it. Every time a bead is touched, a command is given to the control apparatus, by which it is carried out.

A language of its own

A command is only effective if it is understood. This also applies to the commands in the programme for the automatic control. Its "language" is not spoken or taught by any human being, but nevertheless, it is a human invention. It is an electrical language.

Such a command should be given in the form of an electric signal capable of altering the position of a relay. It should, therefore, be recorded in such a way that this "electrical language" can be read.

Several recording methods of this kind are known and are fairly often used in modern daily life.

The recording of commands that can be traced for conversion into electrical signals happens, for instance, when sound-films are made or when sound is recorded on a tape-recorder. As regards the film, the sound is photographically recorded on a narrow strip of the sensitive emulsion, next to the actual picture. Later on, when the film is projected, this track, whilst being illuminated, runs along a photocell which translates the light variations into "electrical language".

With the tape-recorder, magnetic instead of photographic recording takes place. For this purpose the tape is provided with a magnetically sensitive emulsion layer. For recording the sound a so-called "recording head" is used, a small ring-shaped electro-magnet with a narrow air-gap. The alternating current set up by the sound in a microphone, after being amplified, is applied as modulation current to the coil of the electromagnet, causing a varying state of magnetism in the material of the tape. For reproduction, an electromagnet of similar design, called the "play-back head" comes into action, in which the reverse process takes place. Now the varying magnetization of the sound track sets up an alternating voltage in the coil around the magnet, so that the track is again read in the form of an electric signal. During recording, if necessary, an "erasing head" is switched on to erase any previous recording, thus delivering a virginal tape an inch or so further down. Not only is this type of magnetic recording applied in the popular tape-recorders, as used at home, but also in a larger, professional version (employed in air-ports for recording radio communications, etc.). These machines may take up to 15 tracks on a single tape.

Perfotape

For recording the control commands and the sound for the performance of the electronic poem, a system combining perforated tape and the above-mentioned multi-track magnetic tape is used. In this "perfotape system" the tape is passed through a special perfotape machine, two types of which have been installed in the Philips Pavilion.

For recording the sound a machine for triple-track tape is used and for recording the commands for the automatic control a machine for fifteen-track tape. In the latter each of these tracks can accommodate twelve different frequencies, which may be considered as signals. The command tape is thus capable of giving twelve times fifteen or one hundred and eighty different command signals, whose duration may, furthermore, be varied as desired.

- 3 -

The shortest signal lasts about 0.1 second, sufficiently short to direct the instantaneous performance all the time.

Command units behind the perfotape machine have selective elements, each capable of picking up its own specific frequency from the whole frequency spectrum.

These selective elements operate relays, which in turn make the necessary contacts as required by the script, such as switching on or off a given group of light or loudspeakers. Corresponding to the 180 choice possibilities, also 180 control units are required. With a view to any possible breakdown of this very complicated equipment, the whole installation, with the exception of loudspeakers and lamps, has been duplicated, which gives us confidence to run it for six months on end.

Mutual interference of commands by induction should be avoided; therefore, each of the control frequencies used, viz. 10,500 - 8,400 - 6,700 - 5,350 - 4,300 - 3,450 - 2,750 - 2,220 - 1,750 - 1,400 - 1,125 - 900 c/s, differs by about 20% from the adjacent ones.

The relays for circuiting the loudspeakers (one for each loudspeaker) are of the type used in telephone exchanges, which type has proved its reliability. Apart from the relays there are five 4-arm rotatory selectors, each with 100 contacts, for subsequently circuiting the loudspeakers of a group or series with a predetermined speed. This makes it possible that e.g. the sound seems to travel round along a horizontal series of loudspeakers or that it arises from the floor to the top of the building.

Electric coupling

As mentioned before, at two moments there is a connection between the light-, colour-, and projection-play of Le Corbusier, and Varèse's music, a connection which has consequences, particularly for the control apparatus. The sound has been recorded on a separate triple-track tape; the location of the silent moment being determined by the control tape. It will be clear, therefore, that perfect synchronization of control tape and sound tape is required.

The picture must, furthermore, be projected simultaneously on two opposite walls by means of two sets of two projectors in the two projection rooms. The same applies to the four spotlights producing, by means of electrically driven coloured discs, moving colour areas on the wall.

Coupling all the machines to one and the same spindle seems to be the only solution here. In practice, however, this would present enormous mechanical difficulties. Electrical engineering, however, can provide us with an equally effective system of electric coupling, known as the interlock system, which is being used in the pavilion for the perfect synchronization of the perfotape machine and the film projectors. Thanks to the same system it is also possible, to start all the necessary apparatus by pressing a single push-button on the control desk in the central control cabin. The same desk contains a number of measuring instruments by means of which all routine checks on the installation can be made.

Light and projection

The moment the starting button is pressed the sound and command tapes as well as the film in the projectors should be at the appropriate starting point. After starting, a number of synchronous motors, all fed from the same generator, ensure a uniform speed, permitting only insignificant speed fluctuations.

The light is produced by groups of incandescent and of tubular fluorescent lamps in addition to 4 spotlights with coloured discs. The intensity, the location and, with respect to the star-specked ceiling, the movement of the light, are governed by the control apparatus. Part of the light-effects is produced by variation in light intensity, such as a gradual dimming and brightening of the light. This is done with the aid of thyratrons (electronic relay valves), a system also used to control the lighting in cinemas, theatres, etc.

In order, to operate a lamp or group of lamps in accordance with any contingency of the score, up to four relays are necessary: one for gradually increasing the light intensity, a second one for gradually dimming and another two for the instantaneous effects, viz. suddenly full on and suddenly off. There is a total of 2 x 30 servo apparatus for translating the commands of the control tape and 2 x 30 dimming apparatus. The pictures are simultaneously projected by means of four projectors. Two of these are producing the large pictures on the opposite walls, whilst the other two superimpose these with smaller pictures at the appropriate places by means of a mirror-system.

400 Loudspeakers

No less than 400 loudspeakers have been mounted on the walls of the pavilion for reproducing Varèse's composition. Apart from that, twenty-five 20 W loudspeakers are placed behind the railing, specially for reproducing the low tones. Their positions, and accordingly the "path of sound" are more or less determined by the shape of the Pavilion.

- 5 -

A special acoustic arrangement of the composition, distributed over the three sound tracks and control machines, makes it possible to produce sounds differing greatly in their emotional impact upon the listener. The three sound tracks are not only used for recording the acoustical performance, but also for distributing the sound to various fixed spots, or to let it travel along various paths along the wall, the so-called "routes du son". The various groups of loudspeakers are fed via 20 (+ 20 spare) variable amplifiers by 20 (+ 20 spare) power amplifiers of 120 W, whilst for the low-tone loudspeakers an additional 1,000 W amplifier is available. In the interval between two performances, during which the master control apparatus is locked and all tapes are being reeled back into their starting positions, a separate installation is automatically playing a composition by Xenakis, meanwhile the film projectors are producing on the wall a text in three languages explaining the next performance to the new audience filling the Pavilion.

-.-.-.-.-

The whole installation is supplied via a 200 kVA transformer, which steps down the 11,000 V of the high-tension mains to 380/220 V. For operating the relays and other auxiliary equipment, as well as for emergency lighting, there is an accumulator-battery for 60 V d.c. with a capacity of 120 ampère-hours.

A large number of ventilators has been installed for cooling the equipment and for air-conditioning the Pavilion.

-.-.-.-.-

Handwritten musical notation at the top of the page, including dynamic markings **fff** and **pp**, and the instruction "grad. dy. out".

Last page (finale) of
Edgar Varèse's score

Large handwritten musical sketch featuring multiple overlapping lines and curves. It includes dynamic markings such as **mf**, **f**, and **ff**. Annotations include "ad lib?", "cresc.", "decresc.", "limp", and "ton.". A dashed line indicates a "connection amplification".

Edgar Varèse
M. 258-

MM. 112
Spin 5 br.
M.F.P.
1.M. 30 Ton. (11/8) - 3rd stamp
G.M.

Handwritten musical notation at the bottom of the page, starting with a circled number 3. It features rhythmic patterns with stems and flags, and dynamic markings **fff**, **f**, and **mf**. Annotations include "M.M. 112", "M.M. 30", "M.F. pure app", and "M.F. polari : M.M. 30".

- ① 34 21 1 + 10 p. 11
- ② 26 37 2 + 11
- ③ 12 66

teurs

La Composition de le Corbusier et ses collaborateurs
Le minutage, page 3

SEQUENCE II
D'ARGILE ET D'ESPRIT
DURÉE 60"
DE 01" A 120"

S	NOTES	TRITROUS		PAROLES - NOTES
		ENCHAÎNEMENT	VISION	
61	105		LES TRITROUS COLORES SANS IMAGES	ATTENTION! EN SURIMPRESSION SUR LA MUSIQUE: BOUM! BOUM!
62				
63				
64	106			
65				
66	107			
67				
68	108			
69				
70	109			
71				
72	110			
73				ATTENTION! EN SURIMPRESSION SUR LA MUSIQUE PIZZICATO: TIC, TIC, TIC.
74	111			
75				
76	112			
77				
78	113		MIXTURE AVEC TÊTES ET MAINS DES DIVERS SAVANTS	
79				
80				
81	113		LES QUATRE SAVANTS PARMI LES TROUS ÉCLAIRÉS EN COULEURS ET MAINS DES SAVANTS	
82				
83				
84	114			
85	116			

T	VOLUME MAT. FEM.	C R A R	
		ENCHAÎNEMENT	VISION
61			CRÂNE
62			OBJETS. L-C
63			CRÂNE (MUSÉE HOMME)
64			OBJETS L-C
65			CRÂNE (MUSÉE HOMME)
66			OBJETS L-C
67			CRÂNE
68			OBJETS L-C
69			CRÂNE
70			OBJETS L-C
71			CRÂNE
72			OBJETS L-C
73			CRÂNE
74			OBJETS L-C
75			CRÂNE
76			OBJETS L-C
77			CRÂNE
78			LES QUATRE SAVANTS, BALLET DES TÊTES NEZ ET MAINS DES DIVERS SAVANTS
79			
80			
81			LES QUATRE SAVANTS
82			
83			
84			TÊTE DE NÈGRE CONGO
85			TÊTE DE NÈGRE MAORI

GRANDE LUNE
BLANCHE SUR
FOND NOIR
(DIAMÈTRE 1M)

BLEU OUTREMER

AU SOL UN TIERS
OUTREMER TRÈS
SOMBRE, MUR
AUGESSEUS ROUGE
FOND JAUNE
INTENSE

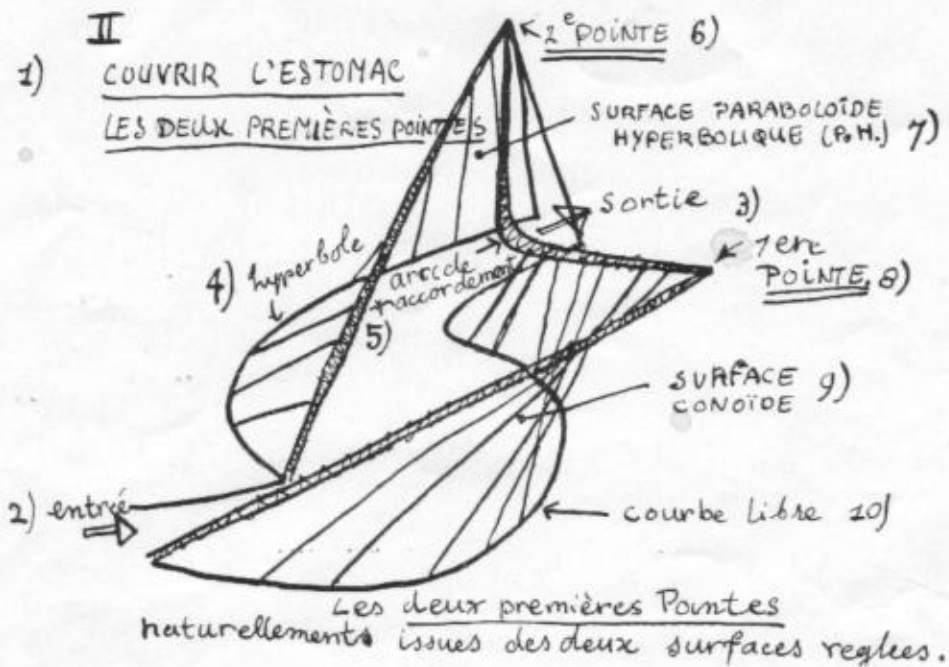

IV 1) EPURATION DE LA FORME

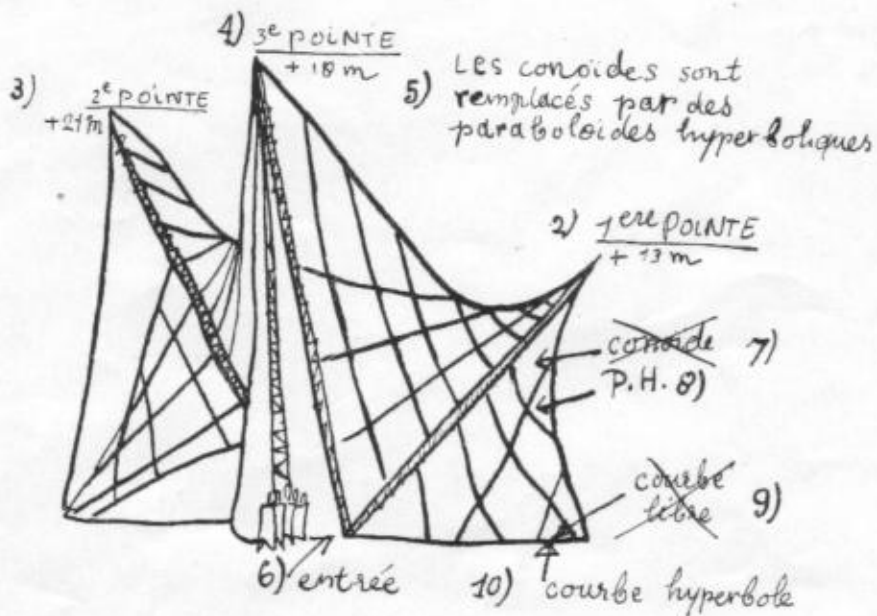

LES ROUTES DU SON

- Route I horizontale
- II vient de I → A
- III B → E → A
- IV U → C
- O B → D → C
- Vet VI par le plan conique
- VII B → U
- VIII C → J
- IX A ↓

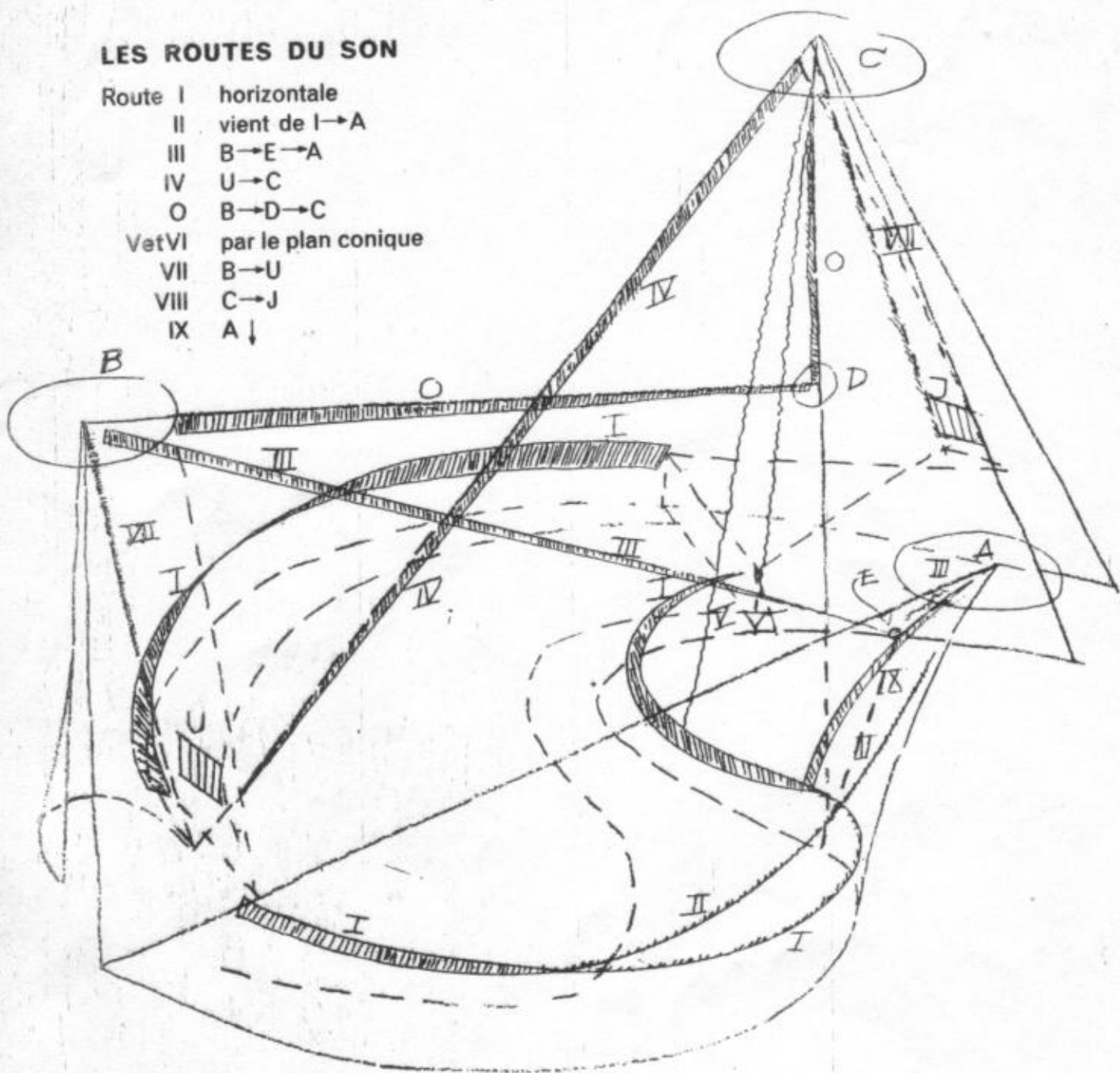

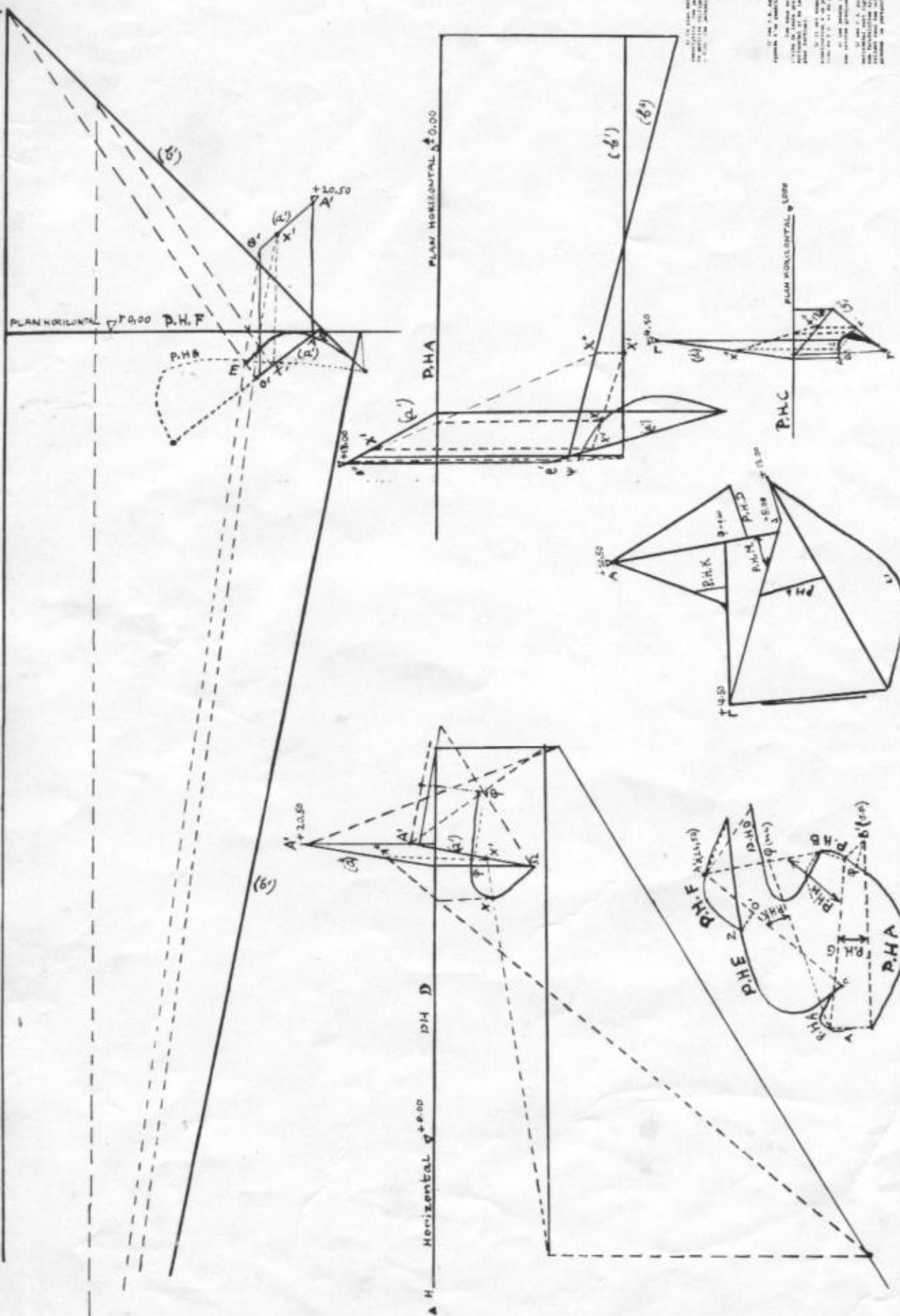

LES PLANS VERTICAUX SONT LES PROJECTIONS
 DES SURFACES HYPERBOLIQUES. LE PLAN
 HORIZONTAL EST LA PROJECTION DES
 SURFACES HYPERBOLIQUES SUR LE PLAN
 HORIZONTAL.

LES PLANS VERTICAUX SONT LES PROJECTIONS
 DES SURFACES HYPERBOLIQUES. LE PLAN
 HORIZONTAL EST LA PROJECTION DES
 SURFACES HYPERBOLIQUES SUR LE PLAN
 HORIZONTAL.

PHIL L C

GEOMETRIE DU PAVILLO

5 4 7 4°

REVUE & PALE 15 RUE DE SEVRES 10710-900

PHIL L C

PLAN GENERAL D'ASSEMBLAGE
 DES PARABOLOIDES HYPERBOLIQUES

Installation of the Philips-Pavilion World-Exhibition Brussels

Music: The program-music has been recorded in three channels on a recorder for perforated tape. The music of each of the channels is fed into a group of regulating- and power-amplifiers.

Groups of loudspeakers or singles ones are alternately switched to the different music-channels by means of relays and rotary-switches of the control-installation. Some 450 loudspeakers of different types are used.

Controls: The controlsignals are given by means of a recorder for perforated tape with 15 channels. The signals are amplified and distributed through control-units. In this way:

- 1) the direct current of the regulating amplifiers is adjusted according to the program
- 2) the loudspeakers are switched of and on
- 3) the servo-apparatus of the lighting-installation is controled.

Lighting: Electronic dimming-devices control the intensity of the light of the lamp-groups of different colours, according to the momentary adjustment of the servo-apparatus.

Filmpro-
jection: By means of two film projectors in each of the two operating-boxes the films are shown on the walls of the pavilion. Synchronism with light and music is controled by the interlock.

The starting and supervision of the program is done on the controldesks.

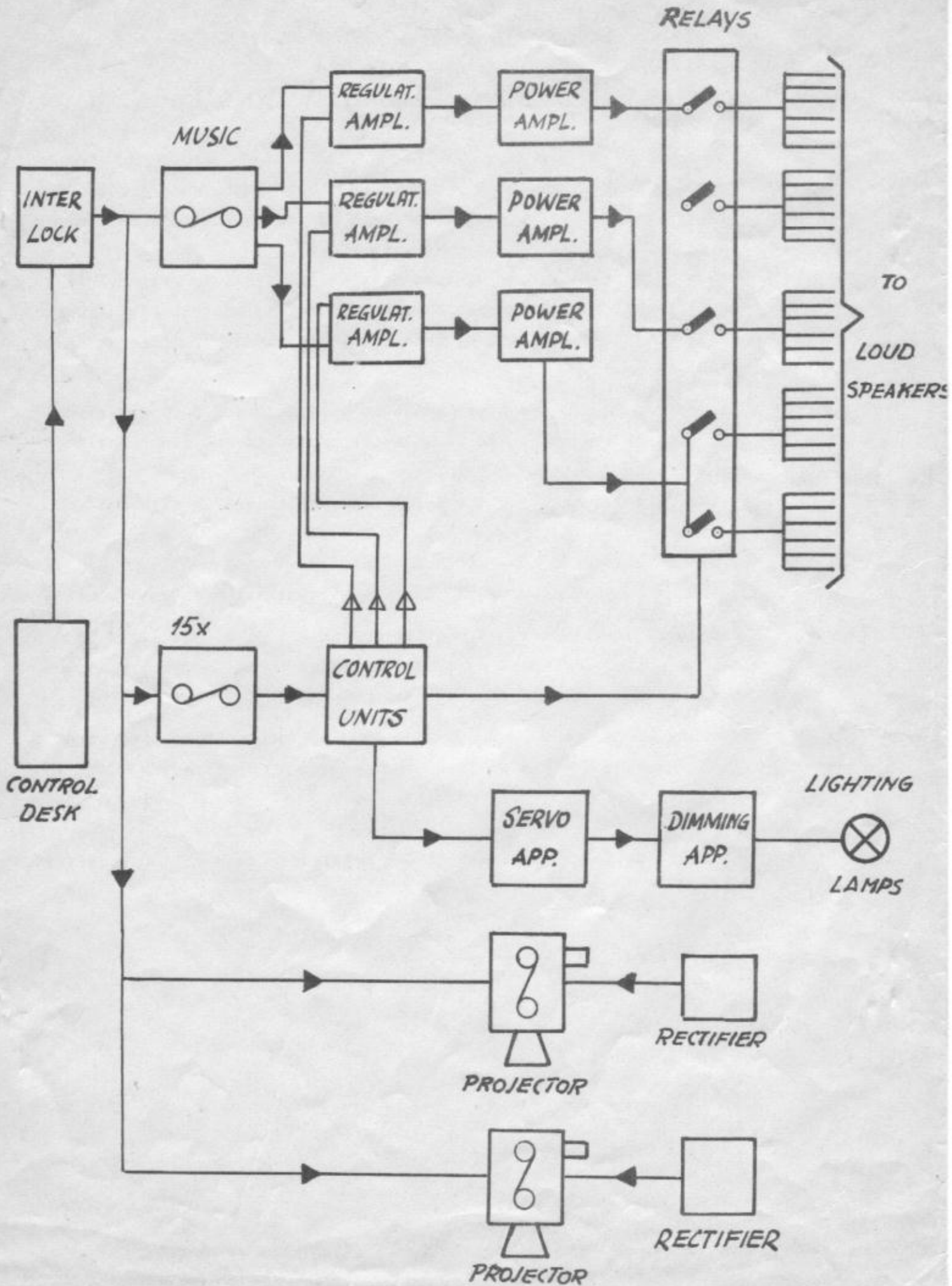

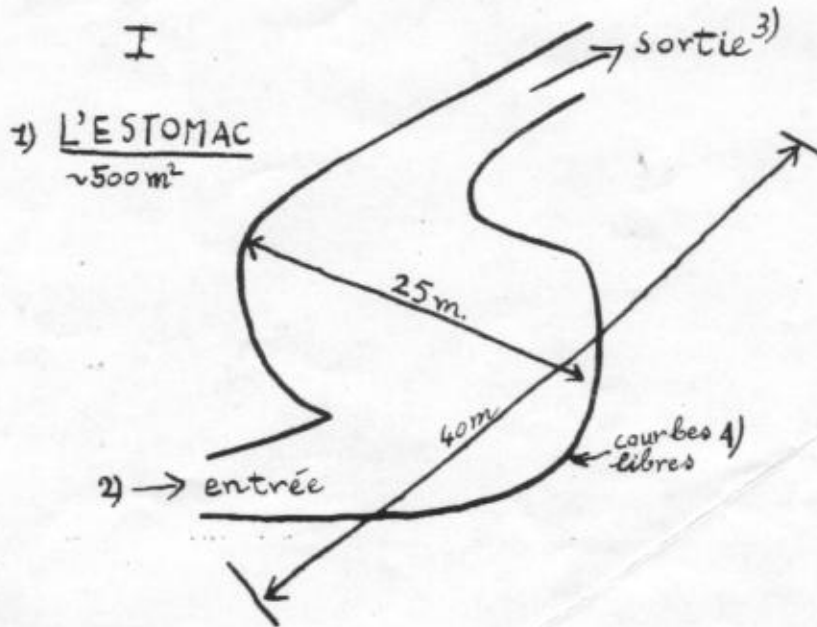

III LA TROISIEME POINTE

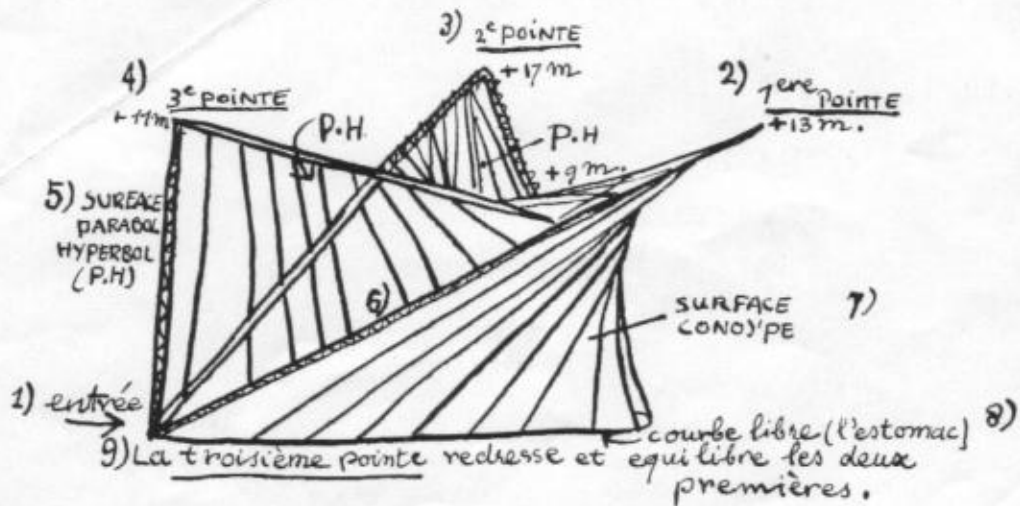

erwijt te
-orkest,

le gaven
wat wij
'Nadat
van een
partituur
hij die in
stechni-
machine.
knopje
klinken,
ar heeft
en boek
erikaan-
n fantast
nuchtere
van zo'n
machine
wij erin

t Varèse
wikkelin-
n verwe-
in 1962:
nooit te-
van het
elding te
gt hij er-
e het ge-
len door
ste, nòg
niet lang
weer zo'n
e elektro-
els bij te

houding
de doel-
Expo wil-
ncern op
nwoordi-
f het for-



Edgar Varèse (links) en ingenieur Tak bij de apparatuur waarmee de componist klanken kon opwekken voor zijn 'Poème électronique'.

FOTO COLLECTIE GAUDEAMUS

de overnamen en veranderingen in at-

← Far above the forest of masts to which the concrete shell was fastened appeared the board on which the passers-by were informed of the exact cause of the activity displayed on this spot.

Twenty-one metres is the distance from the highest peak of the pavilion to ground level. Long ladders bring Léon Matthijs of "Strabed" building company to the correct height from where he will be in a position to direct the mounting of the concrete shell slabs.



→ An inside picture of the pavilion under construction. Mr. W. Tak, Philips' well-known acoustical engineer, watches the mounting of the enormous number of electro-acoustical apparatus.

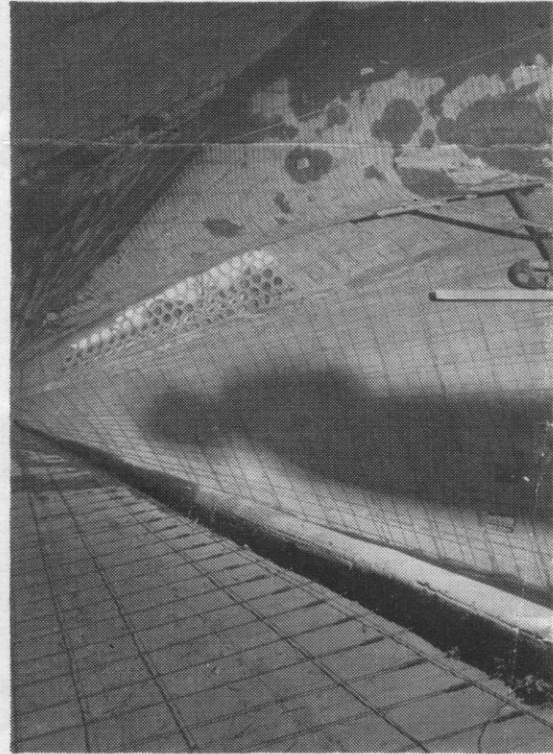

↑ It all started on May 6th 1957. On that day Mr. S. W. Numann, manager of Philips' General Advertising Division, drove the first pile into the soil of the Heysel plain near Brussels for the Philips Pavilion at the "Expo '58". He and Mr. K. K. H. Spaens, delegated manager of Philips Belgium N.V., are shown here as they are looking on how the mighty ram plunges down on the concrete pilehead.



A view of the pavilion from across the Avenue de l'Europe.

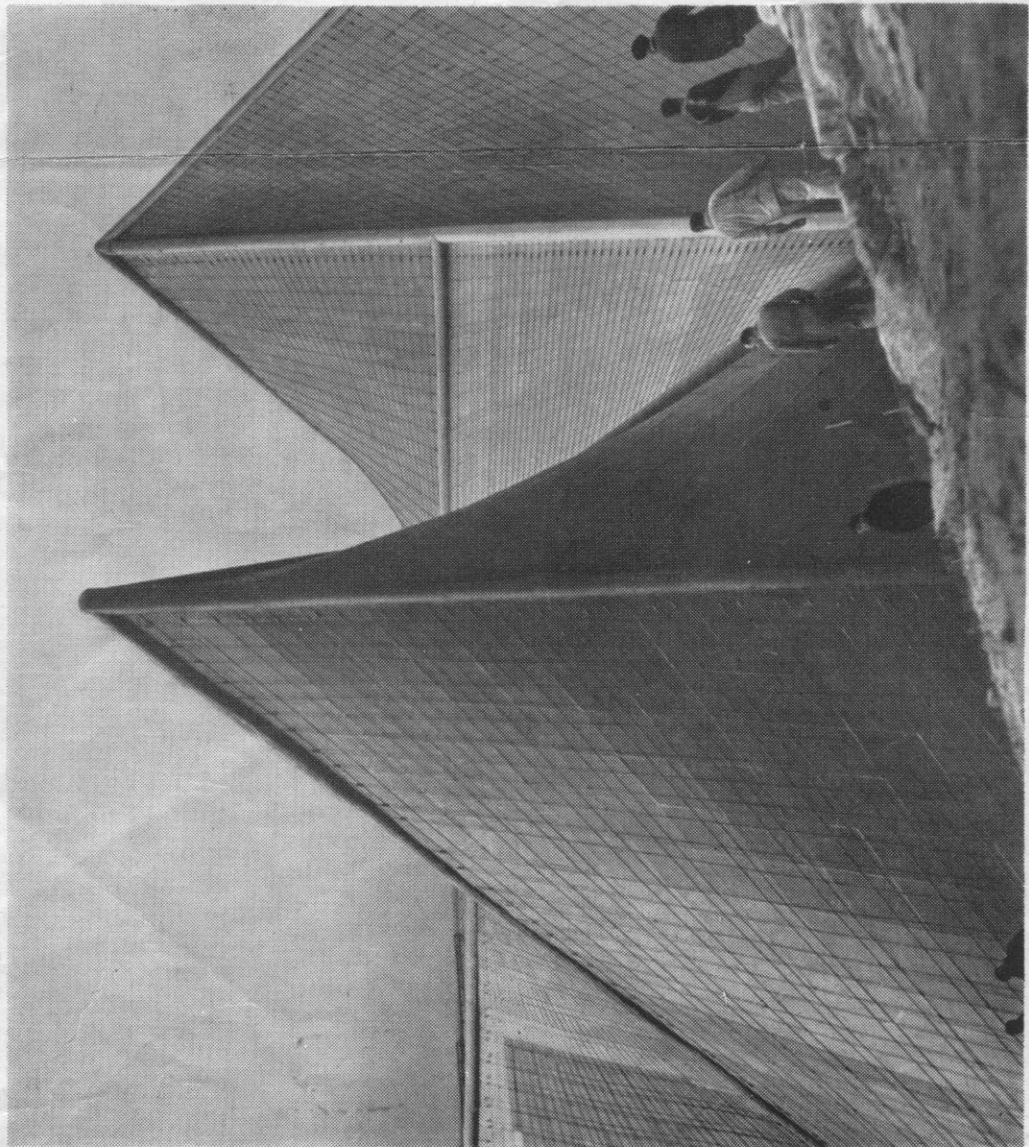
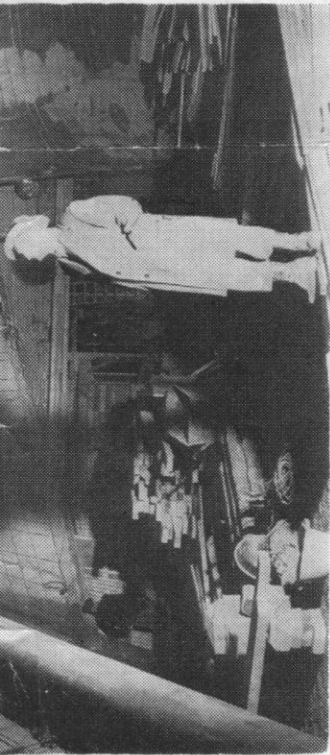
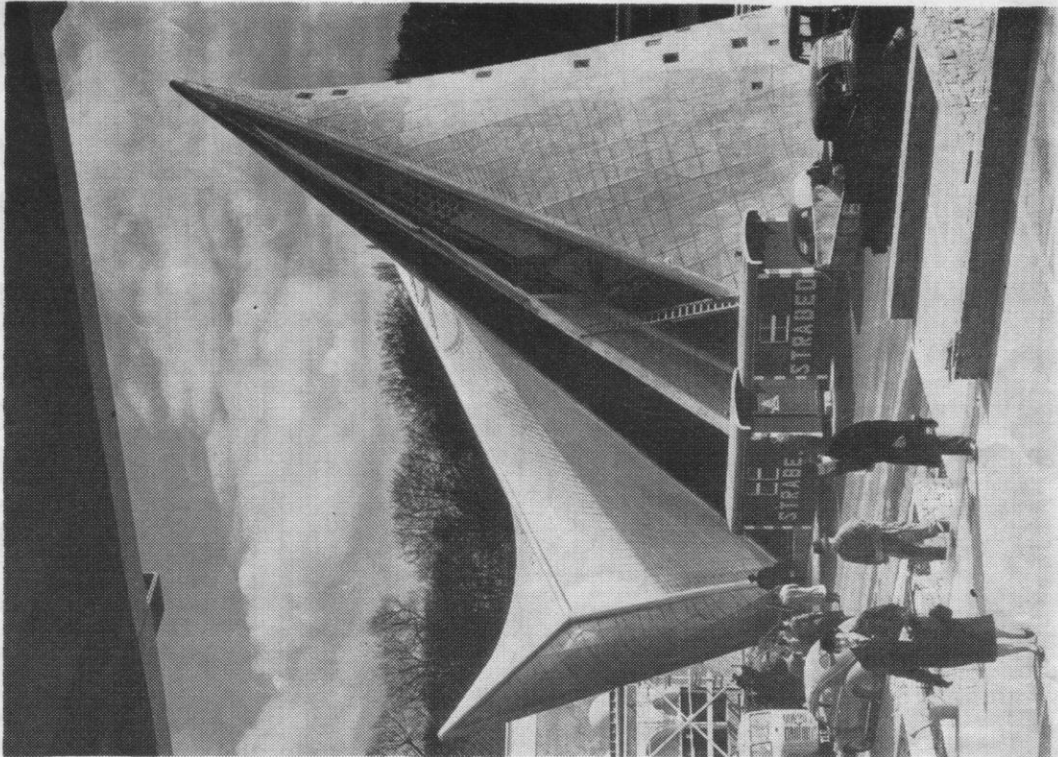

No, this is not the result of a ramble along the monuments of Egypt's great past. It is only one of the many ways in which it is possible to picture the particularly photogenic pavilion, by means of the camera. Hundreds of times already lenses were directed to this extraordinary structure which attracts so much attention, thanks to publications in newspapers and weeklies all over the world. It would seem as if a human hand had put an exotic shell on the beach of phantasy.

Thundering

producing reappearing dying out

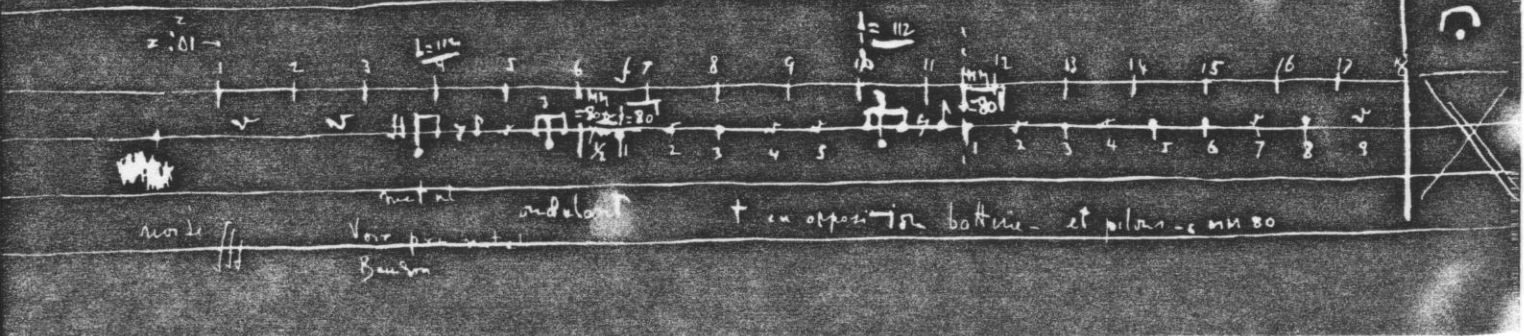
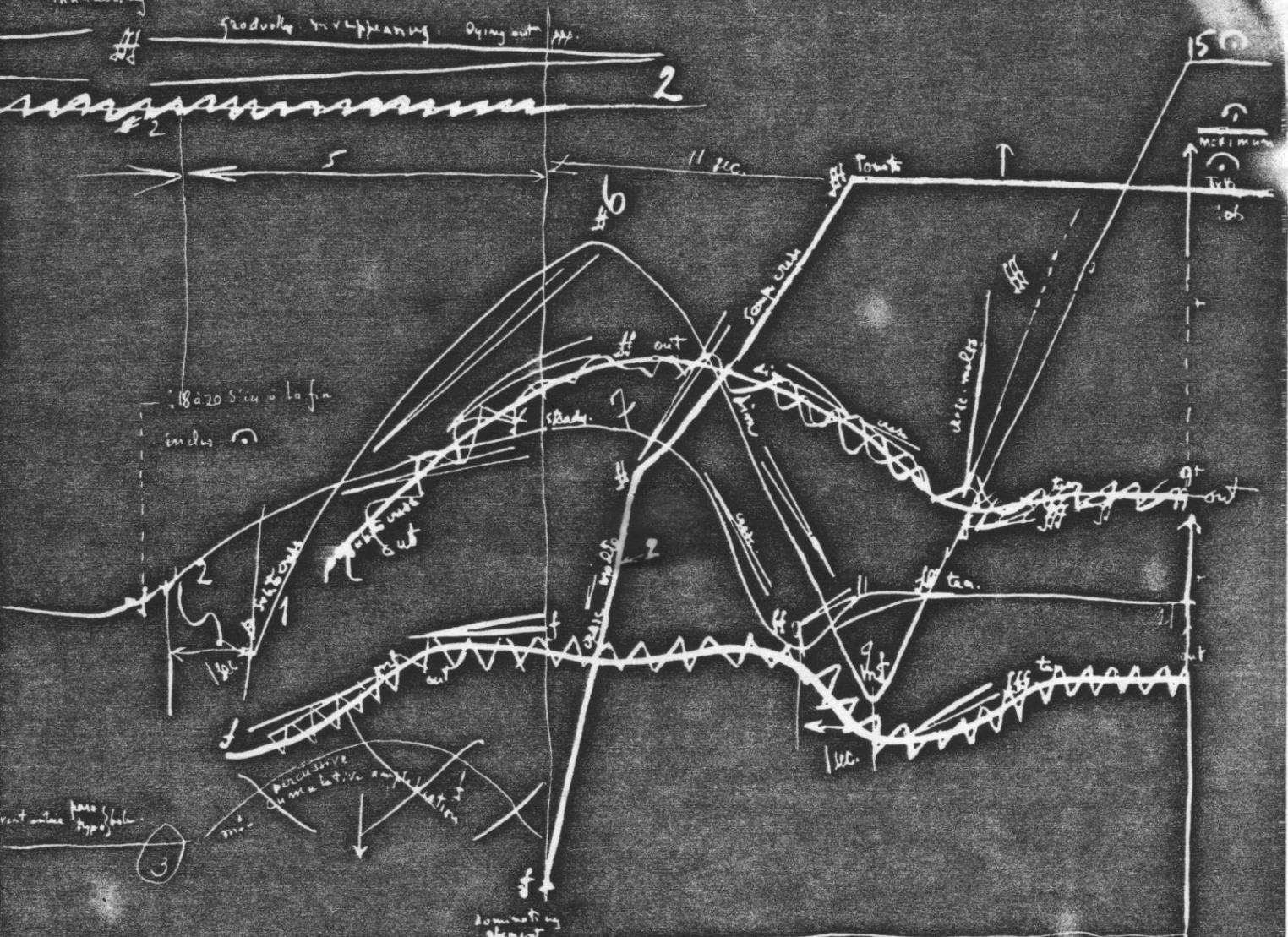

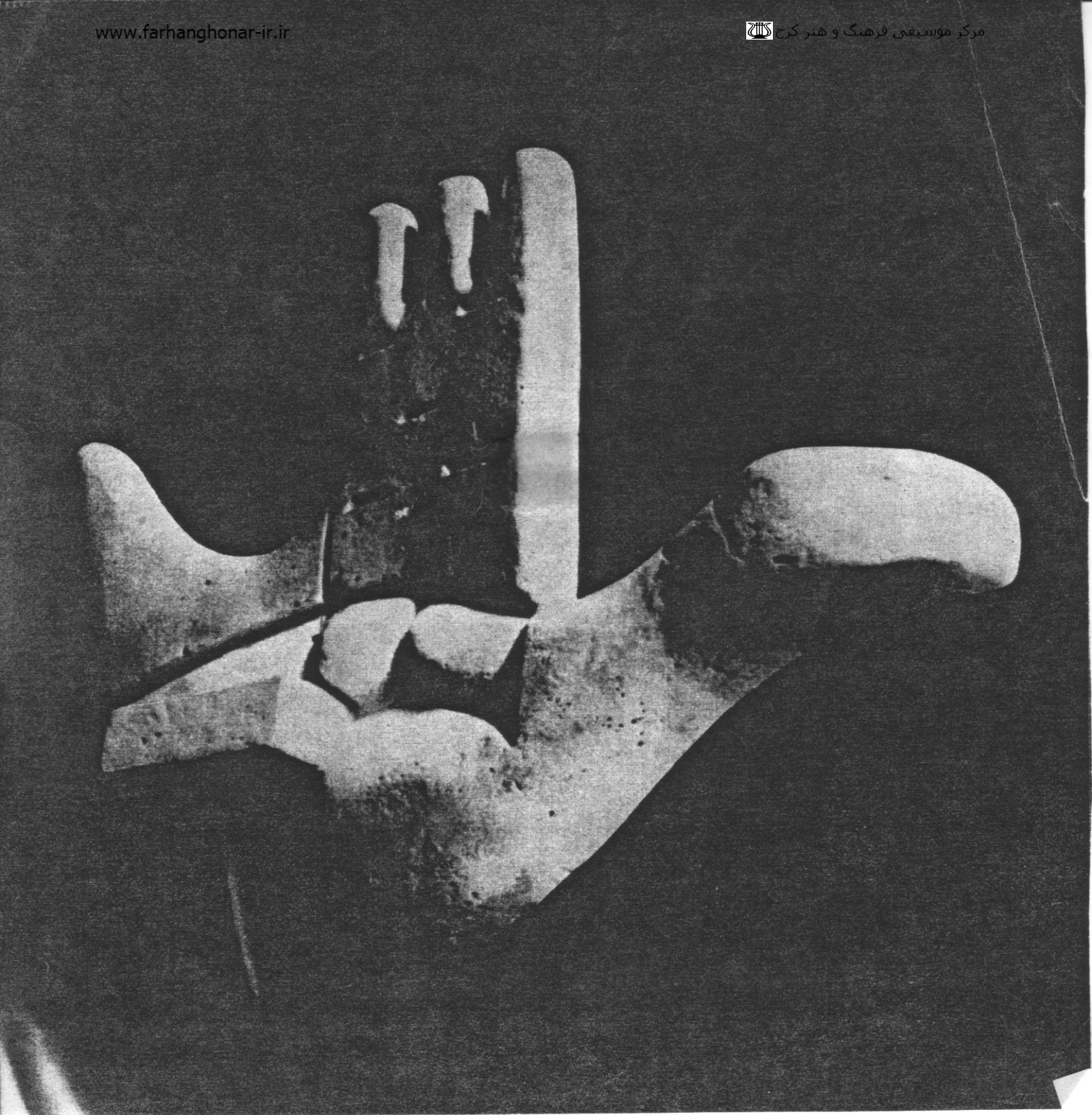

In the Year of the Communist...

- ...of the ... - ... - ... - ... - ... - ... - ...
- ... - ... - ... - ... - ... - ... - ... - ...
: ... of ...

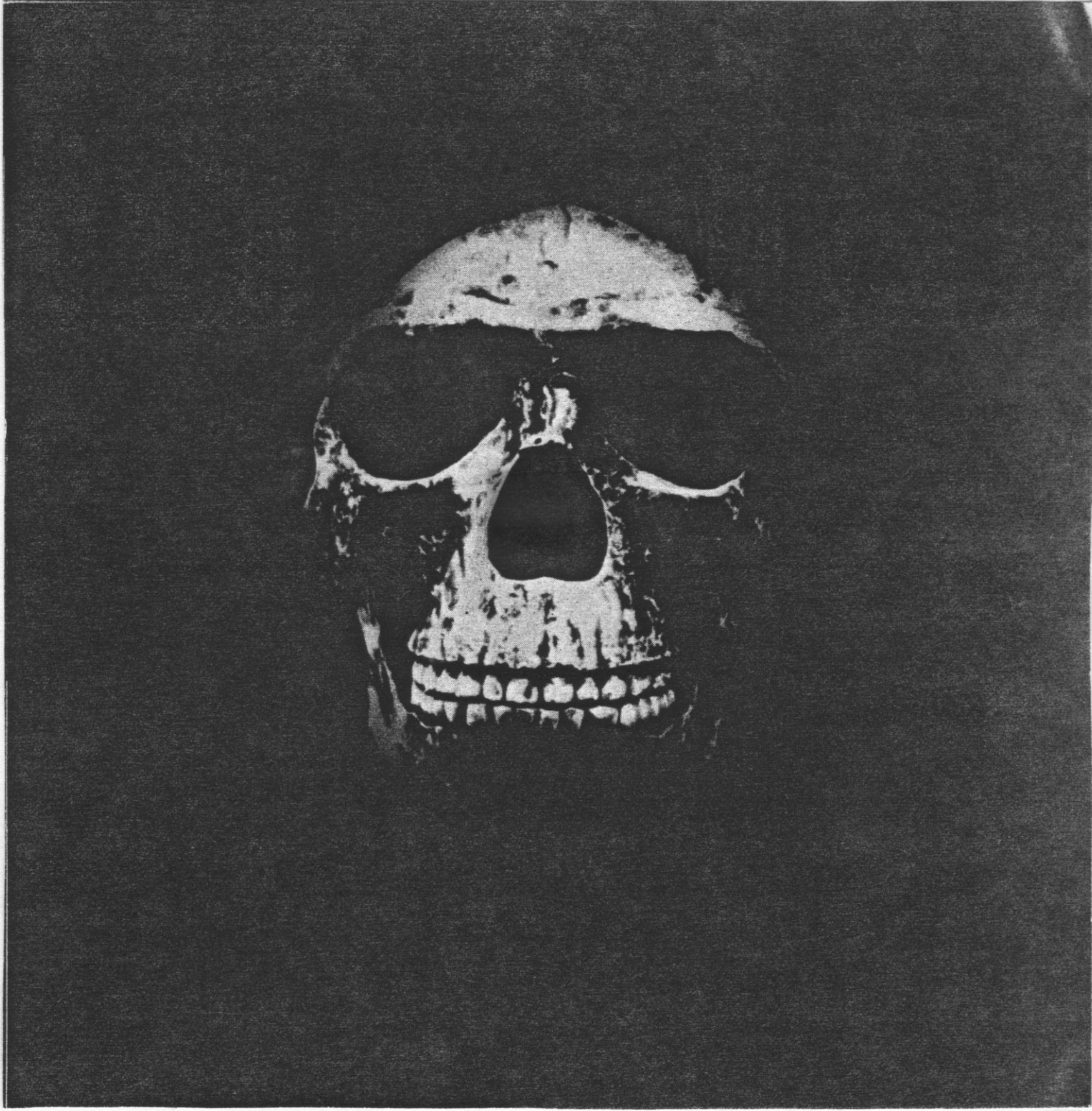

NOMENCLATURE DES IMAGES OPTIQUES

Cette nomenclature est donnée simplement à titre indicatif. Il a paru, en effet, intéressant de donner la liste des documents sélectionnés pour le Poème Electronique, liste qui pourrait déterminer parfaitement les bases d'une sorte de musée imaginatif idéal et qui constitue en elle-même un choix profond.

SÉQUENCE I, DE 0" A 60" : GENÈSE - Les singes, le taureau, le toréador, la tête du jour de Michel-Ange, une femme s'éveille.

SÉQUENCE II, DE 61" A 120" : D'ARGILE ET D'ESPRIT - Crânes, coquillages, pignes, quatre savants, tête de nègre congo, nègre maori, nègre mayogo, fille mangbetu, la femme couchée de Courbet, art attique, art sumérien, l'égypte, dame d'Elche, le masque de César, art celtique, squelette d'homme et dinosaurien, têtes et mains de singes, les buffles, les masques eskimo, la grâce : Milo, art de Ceylan, art de la Sibérie, art de Ceylan.

SÉQUENCE III, DE 121" à 204" : DES PROFONDEURS A L'AUBE - Yeux de hibou, hibou, pintade, dindon, œil de femme, tête de cigale, requin, coquillages, dieux de la guerre, des pierres, le roi de Dahomey, geso, dieux de la guerre, la main du squelette de Cro-Magnon, camps de concentration, jouets guerriers, descente de croix de Giotto, un Christ 12°, une Nativité de Chartres, une vierge et enfant, l'Ange de l'Annonciation, Dieu, le grand compatissant, la Vierge de douleur.

SÉQUENCE IV, DE 205" A 240" : DES DIEUX FAITS D'HOMMES - Ile de Pâques, tête Ankor, coquillage, le Boudha, coquillages, siècle grec, art nègre, le Boudha, les mains de Boudha, Ile de Pâques.

SÉQUENCE V, DE 241" A 300" : AINSI FORGENT LES ANS - La foule, un ingénieur atomique, travailleur au télescope, travailleurs au givre, stratosphère, télescope, soudeur, fonte d'acier, chirurgiens, mineurs, cimentiers aux Indes, bœuf de labour, cheval de ferme, les cocasses : Charlot, ainsi que Laurel et Hardy, la crémaillère de l'usine, bombardiers, fusée radar, fusée et lune, des enfants inquiets regardent, explosions nucléaires, l'écheveau embrouillé.

SÉQUENCE VI, DE 301" A 360" : HARMONIE - Les treillis ordonnés de la tour Eiffel, divers éléments et pièces mécaniques de machines, galaxie, éclipses solaires, flammes solaires, les cocasses : Laurel et Hardy, deux amoureux sur un banc, deux amoureux qui s'embrassent, les bébés.

SEQUENCE VII, DE 361" A 480" : ET POUR DONNER A TOUS - Les 4 gratte-ciels de Paris, la ville hirsute : New-York, les cités radieuses de Marseille et de Nantes, la ville de Chandigarh aux Indes, le Nautilus et le Modulor, gratte-ciel d'Alger, un mur hirsute, une ville hirsute, un mur appareillé, un plan de Paris ; Le Corbusier, l'urbanisme d'Alger, les routes d'Europe, jeux de deux enfants, la main ouverte, la capitale de Chandigarh aux Indes, une femme seule, un gosse seul, une mémère seule, un garçon seul, clochard, gosses, un chemin dans la boue, le ballet des bébés.

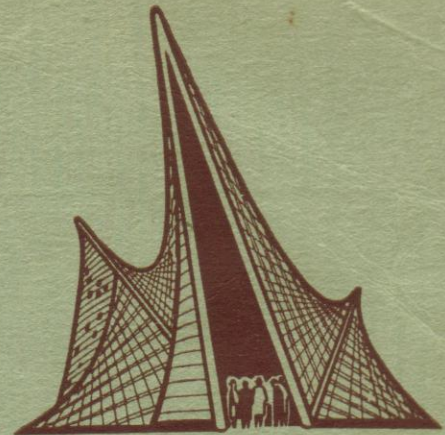

poème électronique

PHILIPS PAVILION WORLD EXHIBITION BRUSSELS 1958

